

SS1053DS / SS10531DS Dock Mount Hoist

Your **Shore-Station** PWC Boat Hoist is designed to give years of dependable service. Following the instructions in the operator's manual will insure its dependability and more important, **YOUR** safety. Read through this entire operator's manual before attempting to operate your hoist. Our goal is your safety - help us help you by knowing and observing the operating precautions and limitations you will find listed herein. If you do not understand any of these instructions, please ask your dealer for his personal attention to your questions.

Midwest Industries, Inc.
Ida Grove, IA 51445

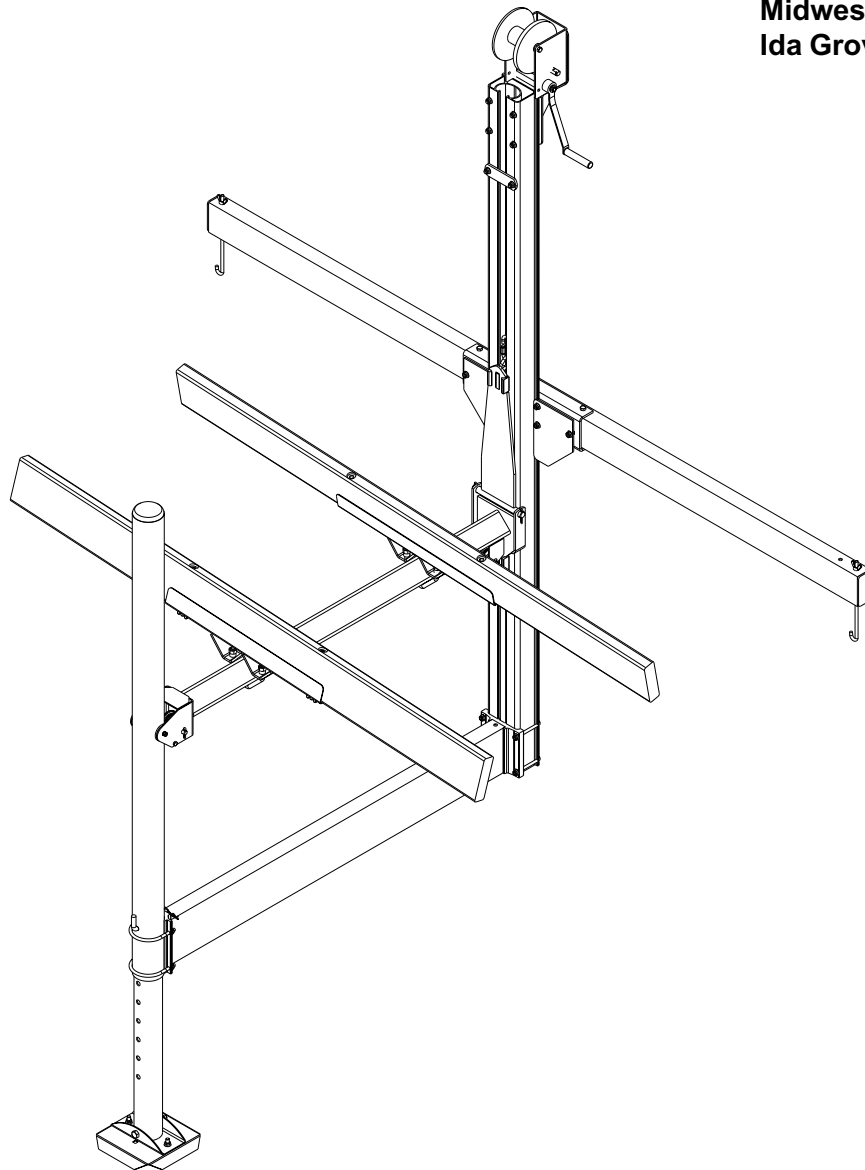

DWG: SS1053DS REV: 1.0

ITEM	PART #	DESCRIPTION	QTY	NOTE
1	62538	BUNK CHANNEL WMENT LEFT	1	
2	62550	SQUARE BASE PAD	1	
3	63435	BUNK CHANNEL WMENT RIGHT	1	
4	63732	1/2" PULLEY PIN	1	
5	65285	PWC DOCK MOUNT TUBE	1	
6	66003	LOWER FRAME WMENT - DOCK MTG HOIST	1	
7	66006	UPPER LIFT ARM WMENT	1	
8	66014	PLATFORM WELDMENT - DOCK MOUNT	1	
9	66015	GUIDE POST TUBE	1	
10	66016	LEG ADJUSTMENT PIN	1	
11	66017	WINCHPOST MOUNTING CHANNEL	1	
12	66018	HOIST ATTACH PLATE	2	
13	66019	STOP PLATE	1	
14	66021	WINCH POST EXTRUSION - 90"	1	A
15	66023	PULLEY SPACER BUSHING	2	
16	66025	BUNK ASSY - LEFT 853/8531	1	
17	66026	BUNK ASSY - RIGHT 583/8531	1	
18	66033	PLATFORM ASSEMBLY SS853/8531DS	1	
19	66034	PLASTIC GUIDE WASHER - 853/8531	2	
20	68509	WINCH MTG BRACKET	1	
21	0110019	HH 1/4-20 X 4 1/2 CS GR5 ZP	1	
22	0110037	HH 3/8-16 X 1 1/4 CS GR5	3	
23	0110056	HH 3/8-16 X 3 1/4 CS GR5	2	
24	0110059	HH 3/8-16 X 3 3/4 CS GR5	6	
25	0110118	HH 1/2-13 X 4 1/2 CS GR5	1	
26	0120316	SCREW(PROJECTION WELD) 1/4-20 X 1/2	2	
27	0140040	HH 3/8-16 X 1 CS GR5	2	
28	0210102	CARR 3/8-16 X 1 GR5	6	
29	0210139	CARR 3/8-16 X 6 FULL THREAD GR5	4	
30	0310295	SUB 3/8 X 5 3/16 X 3 7/8	2	

31	0320101	3/8-16 X 3 7/8 X 3 7/8 ROUND U-BOLT	2	
32	0330000	1/2-13 X 4 19/32 X 3 3/4 V-BOLT	2	
33	1010073	3/8-16 X 10 1/2 HOOK BOLT	2	
34	1310020	LOCKWASHER 1/4 S/T MED	2	
35	1340095	WASHER USS FLAT 3/8	4	
36	1410049	HEX NUT FINISH 1/4-20	2	
37	1410059	HEX LOCKNUT 1/4-20 GRA	1	
38	1410109	HEX NUT 3/8-16	1	
39	1410110	WING NUT 3/8-16	6	
40	1440101	HEX LOCKNUT FLANGE 3/8-16 W/T&T	25	
41	1440102	HEX LOCKNUT FLANGE 1/2-13 W/T&T	1	
42	1440179	HEX LOCKNUT 1/2-13 GRA	4	
43	1510078	COTTER KEY 3/16 X 1	4	
44	1520082	COTTER KEY 3/16 X 1 1/2	2	
45	1540300	HITCH PIN CLIP #7	1	
46	1910048	PULLEY PIN	1	
47	2210171	CHAIN QUICK LINK W/5/16 OPENING	1	
48	3110351	CABLE LEVEL III 1/2" STAINLESS	1	
49	3110391	WINCH DLB2000A W/72" STRAP	1	A
50	3510083	PLATFORM PULLEY W/BRONZE BUSHING	2	
51	3510126	SLIDE BLOCK - PWC DOCK MOUNT	2	
52	3810097	SPACER .5151D X 11/16OD X 7/16 LONG	4	
53	3910024	BUNKWOOD 2 X 6 X 12FT FIR	2	
54	A102	ADJUSTABLE LEG 3 1/8OD X 30 1/2	1	
55	A104	ALUM BASE PAD CHANNEL CLAMP	1	
56	A389	BLACK PLASTIC CAP	1	
57	S-547	2X4 SL PLASTIC END CAP	2	

NOTES	
A	For SS10531DS use 66022 WINCH POST EXT 120 IN and 3110392 WINCH DLB2000A W/102" STRAP

SS1053DS / SS10531DS Bundles Required

SS1053DS Dock Mount Hoist 1000 lbs.

66003	Lower Frame Wment 853/8531
66027	Bunk Bundle 853/8531
68518	Hardware Box 1053DS
66031	Leg Bundle SS853
66033	Platform Bundle 853/8531

SS10531DS Dock Mount Hoist 1000 lbs.

66003	Lower Frame Wment 853/8531
66027	Bunk Bundle 853/8531
68512	Hardware Box 10531DS
66032	Leg Bundle SS8531
66033	Platform Bundle 853/8531

Tools Required

9/16" Socket/Wrench
3/4" Socket/Wrench

Replacement Parts

304844*	71-15/16" WINCH STRAP-SS853DS
304845*	102" WINCH STRAP - SS8531DS
404933*	WINCH STRAP HOLD DOWN CLIP
205345*	#10-24 X 1/2" PHIL FLAT HEAD SCREW

* DL Replacement Numbers

DWG:SS1053DS	REV:1.0+
--------------	----------

SS1053DS / SS10531DS Parts Drawing

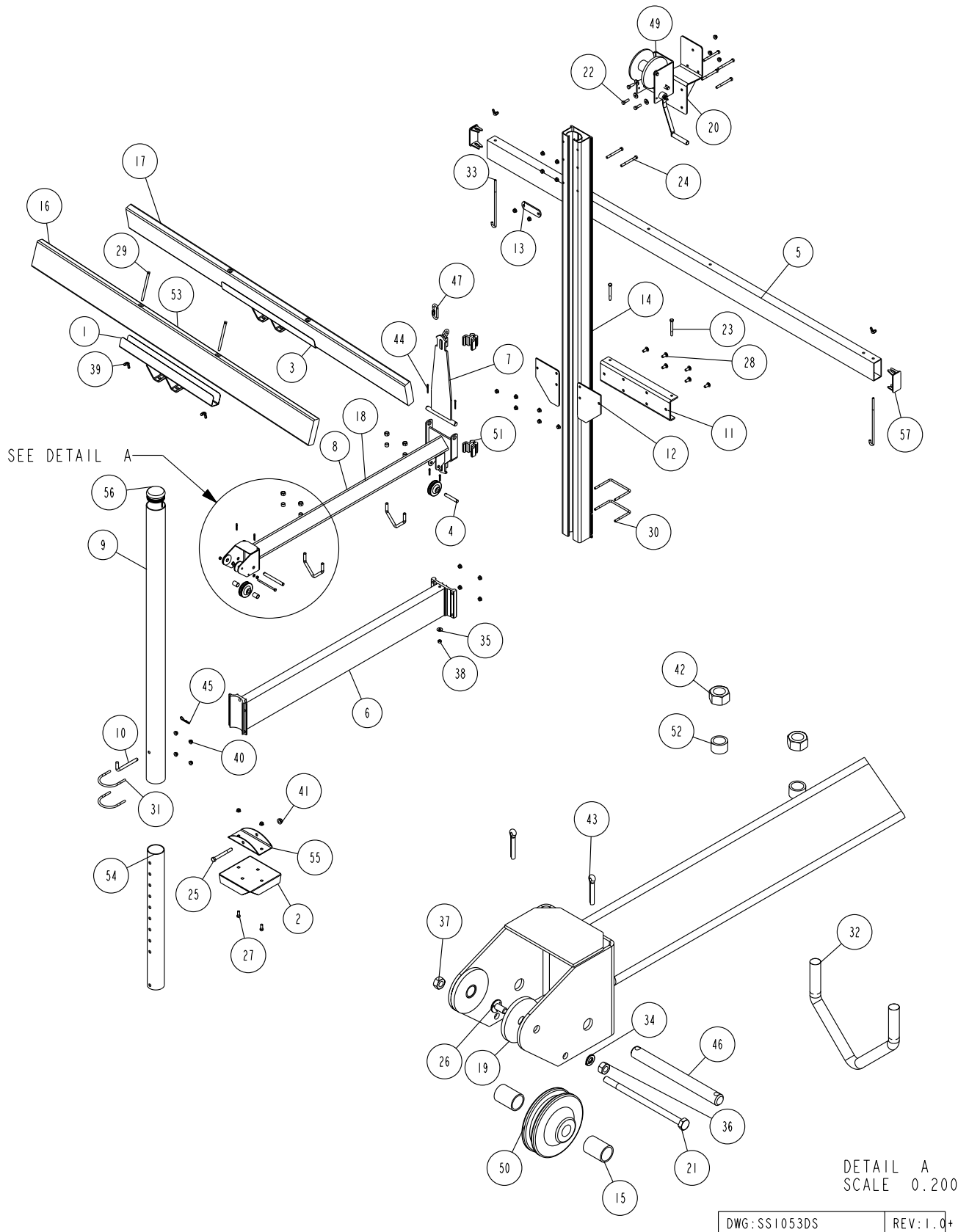

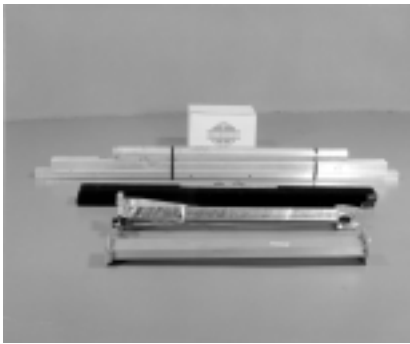

1. Bundles as shown.



2. Hardware box as shown.

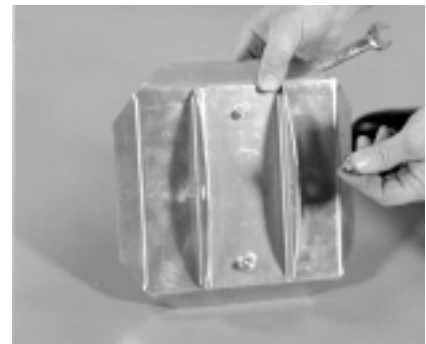

3. Install the aluminum base pad channel clamp to the base pad using two (2) 3/8" X 1" hex bolts and two (2) 3/8" flange lock nuts.

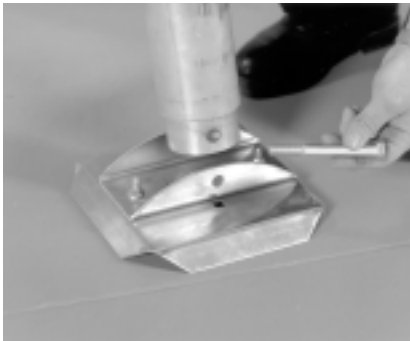

4. Mount the adjustable leg to the base pad channel using a 1/2" X 4-1/2" hex bolt and secure with a 1/2" flange lock nut.



5. Mount the lower frame weldment (Ref.#6) to the winch post extrusion (Ref.#14) using two (2) 3/8" X 5-3/16" X 3-7/8" square u-bolts (Ref.#30) as shown. Secure with 3/8" flange lock nuts.

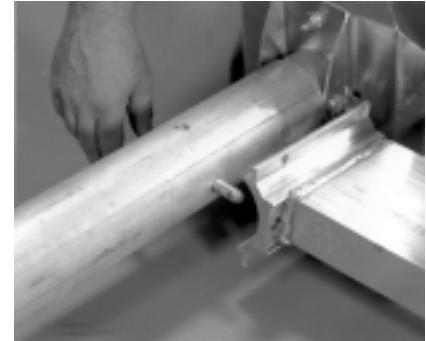

6. Mount the guide post tube (Ref.#9) to the opposite end of the lower frame weldment using a leg adjustment pin (Ref.#10). Secure with a hitch pin clip (Ref.#45).



7. Also mount the guide post tube to the opposite end of the lower frame tube using two (2) 3/8" X 3-7/8" X 3-7/8" SUB's. Secure with 3/8" flange lock nuts.

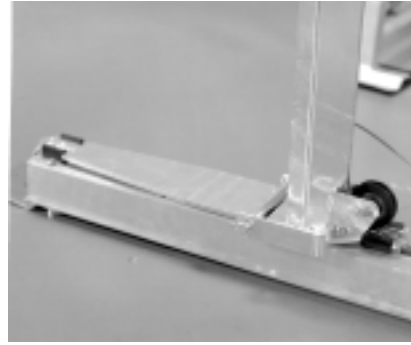

8. Slide the platform assembly (Ref.#18) into the winch post extrusion (Ref.#14) as shown.

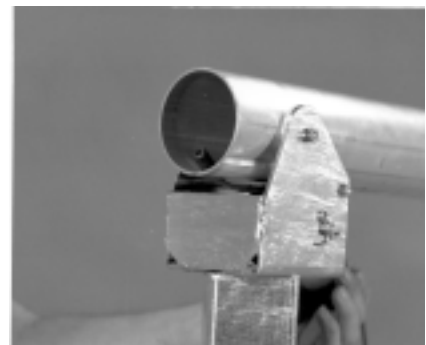

9. Slide the opposite end of the platform assembly over the guide post tube as shown. **Note: Be sure that the cable end is in the notch in the end of the guide post.**

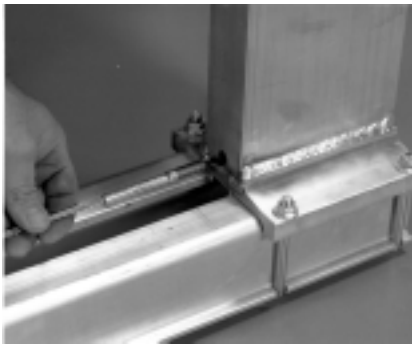

10. Run the threaded end of the cable through the lower frame weldment as shown.

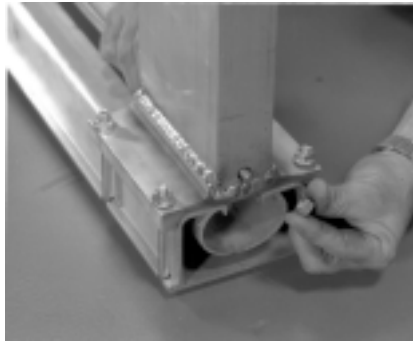

11. Secure the cable end to the under side of the lower frame weldment with a 3/8" flat washer and 3/8" hex nut.

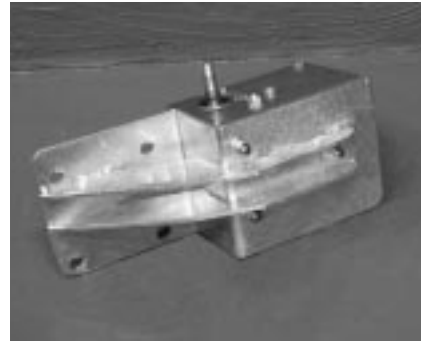

12. Mount the winch mounting plate (Ref.#20) to the winch assembly (Ref.#49) using three (3) 3/8" X 1" hex bolts. Place a 3/8" flat washer on each of the three (3) 3/8" X 1" bolts. Insert the bolts into the slots of the winch base. Align with the mounting holes in the winch mounting bracket. Secure with 3/8" flange lock nuts.



13. Mount the winch assembly with winch mounting bracket to the winch post extrusion using the four (4) 3/8" X 3-3/4" hex bolts (Ref.#24) just installed. Place a 3/8" flat washer on each of the four (4) 3/8" X 3-3/4" hex bolts. Insert them into the holes provided in the top of the winch post extrusion. Secure with 3/8" flange lock nuts.



14. Unwind the strap from the winch. Connect the end of the winch strap to the platform weldment assembly as shown.

NOTE: The strap must be free of any twisting.



15. Mount the stop plate (Ref.#13) to the winch post extrusion using two (2) 3/8" X 3-3/4" hex bolts (Ref.#24). Secure with 3/8" flange lock nuts.

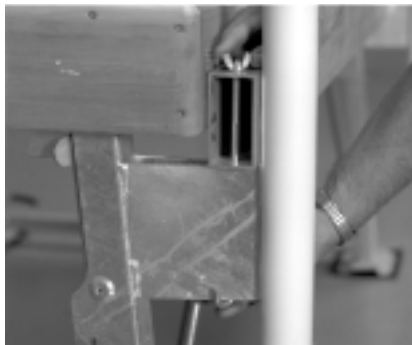

16. Mount the dock mount tube (Ref.#5) between the dock and bumper as shown. Secure the dock mount tube using a 3/8" X 10-1/2" j-hook (Ref.#33) hooking from the bottom of the dock leg universal bracket up as shown. Secure with a 3/8" wing nut (Ref.#39).



17. Insert the ShoreLand'r end cap into the ends of the dock mount tubes as shown.



18. Mount one (1) hoist attach plate (Ref.#12) to the winch post mounting channel (Ref.#11) using three (3) 3/8" X 1" carriage bolts (Ref.#28). Secure with 3/8" flange lock nuts. **NOTE: The hoist attach plate must be hooked over the lip on the winch post extrusion.** Place the other hoist attach plate onto the opposite side of the winch post extrusion - be sure this plate extends over the lip of the winch post extrusion before tightening.



19. Mount the entire hoist by sliding the winch post mounting channel over the dock mount tube (Ref.#5) and drop two 3/8" X 3-1/4" hex bolts down through holes on winchpost mounting channel to secure the hoist to the dock.



20. Insert the black plastic cap (Ref.#56) into the guide post tube as shown.



21. Slide the blue cover over the winch assembly as shown. This cover is used to protect the winch assembly from the weather.

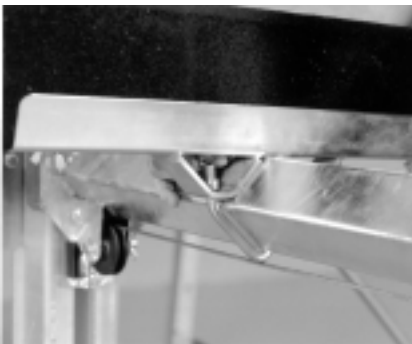

22. Mount the bunk with brackets onto the platform weldment using two (2) 1/2" v-shaped u-bolts (Ref.#32), two (2) spacers (Ref.#52) and two (2) 1/2" hex lock nuts (Ref.#42) per bunk as shown. **Note: The short end of bunk from galvanized mounting channel goes to the right of the winch handle (as reference - Refer to picture 23 for Right and Left of hoist).** Repeat on other bunks. Bunks should be spaced to fit your watercraft before tightening. Bunks should also be angled toward the center of the platform. **NOTE: To enter the dock hoist from the other end - reverse the bunk assembly.**

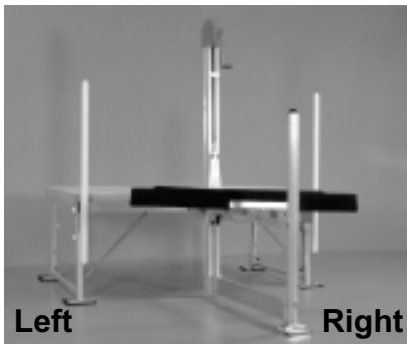

23. SS853DS shown with assembly being complete.

Caution: Before attempting to install and or operate this hoist, we strongly recommend (both for your safety and that of your equipment) that you study and fully understand the proper operating procedures and safety precautions outlined on page 7 of this owner's manual.

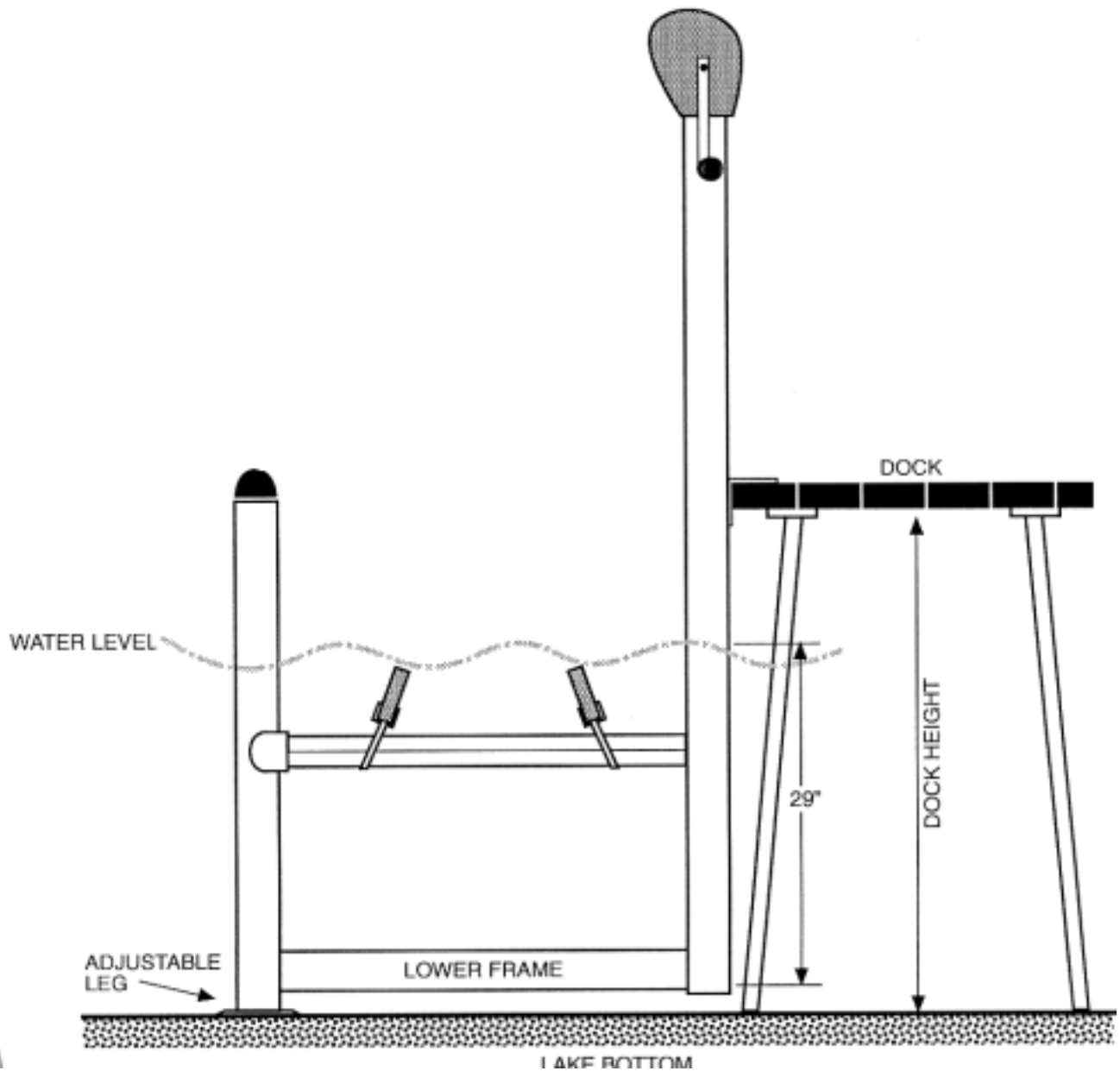

After final assembly, you are now ready for installation. Once the location is determined you need to find the water depth and the dock height.

Using a pole or a 2X4, insert it into the water and locate solid bottom to water level. Mark both the water level and the top of the on the 2X4.

Remove the pole and measure the distance from solid bottom to water level.

You must allow 17" for the lower cross member and bunk height, then add floatation allowance plus the water distance to the top of the dock figure, dock mount tube should be set at this measurement. Subtract this measurement from the lake bottom to the top of the dock measurement to get the leg extension measurement. **NOTE:** Allowances may have to be made for uneven lake bottom in the leg setting measurement.

The distance of dock to water line plus 29" equals position to set the top of the dock mount tube.

Safety Tips

“The best insurance policy is safety”

After the hoist installation is complete, it is important to next check and see that the winch mechanism is functioning properly. This is easily accomplished by raising the empty platform about one-fourth the way up and releasing your grasp on the lift handle. If the winch is operating properly, the clutch brake will automatically hold the platform at any position. Perform this same test in the half, three-fourths and full lift positions. Next, repeat this same procedure with your boat on the hoist. If the lift handle begins to freely spin down from any of these test positions, at no time should you attempt to prevent it from doing so. Such action could result in injury to arms and hands. Instead simply let the platform spin down into the water. Doing so will neither damage your hoist nor your watercraft.

If for some reason your winch mechanism does not function as described call your authorized Shore Station dealer. Do not tamper with the winch mechanism.

SAFETY PRECAUTIONS

DO NOT OPERATE THIS HOIST WITHOUT FIRST STUDYING THIS OWNER’S MANUAL

1. See to it that you, your family, and anyone else who uses the hoist looks upon the unit not as a toy, but a piece of heavy equipment that deserves your respect and good judgment.
2. Before allowing anyone to operate the unit, be sure they fully understand the proper operating procedure.
3. Do not exceed maximum capacity unit, overloading may cause mechanical failure and serious personal injury.
4. All persons should stand clear and should not be allowed to board your watercraft when it is being raised or lowered.
5. If you choose to remove the winch cover and inspect or work on the winch, be sure the platform is completely lowered.
6. It is a good safety policy to restrict children, as well as adults, from playing on or near the hoist.
7. Service winch annually. **IMPORTANT:** Winch maintenance schedule must be followed to avoid possible failure and injury. See winch owner’s manual for instructions.
8. Check cable for wear or fraying and also stress on cable attaching ends. If this occurs, replace cable immediately.
9. Be sure the hoist is installed level, severe out of level installation may cause hoist hand up and serious personal injury.
10. Do not work on you watercraft or hoist with watercraft on the hoist.
11. Check all sheaves, make sure they are turning and operating properly.
12. Check fasteners on cable ends to be positive they are threaded properly (see setting up instructions).
13. If the winch handle begins to freely spin down for any reason, at no time should you attempt to prevent it from doing so. Such action could result in injury to arms and hands. Instead, simply let the platform spin down into the water. Doing so will neither damage your watercraft or hoist.
14. Never pick up on platform of hoist while trying to move, position, or transport hoist. Doing so may cause serious personal injury.
15. Never stand or walk on hoist platform while in any raised position. Doing so may cause serious personal injury.

SAFETY MAINTENANCE

It is recommended that your Shore Station hoist be thoroughly inspected at least once each season:

1. Tighten all bolts.
2. Check pulleys and make sure they are all turning freely.
3. Inspect all cables for fraying, wearing or deteriorating. If any signs appear, replace cables.
4. Check frame thoroughly.
5. Check winch as per manufacturer’s specifications.