

### SS1053D / SS10531D Dock Mount Hoist

Your **ShoreStation** PWC Boat Hoist is designed to give years of dependable service. Following the instructions in the operator's manual will insure its dependability and more important, **YOUR** safety. Read through this entire operator's manual before attempting to operate your hoist. Our goal is your safety - help us help you by knowing and observing the operating precautions and limitations you will find listed herein. If you do not understand any of these instructions, please ask your dealer for his personal attention to your questions.

**Midwest Industries, Inc.**  
Ida Grove, IA 51445

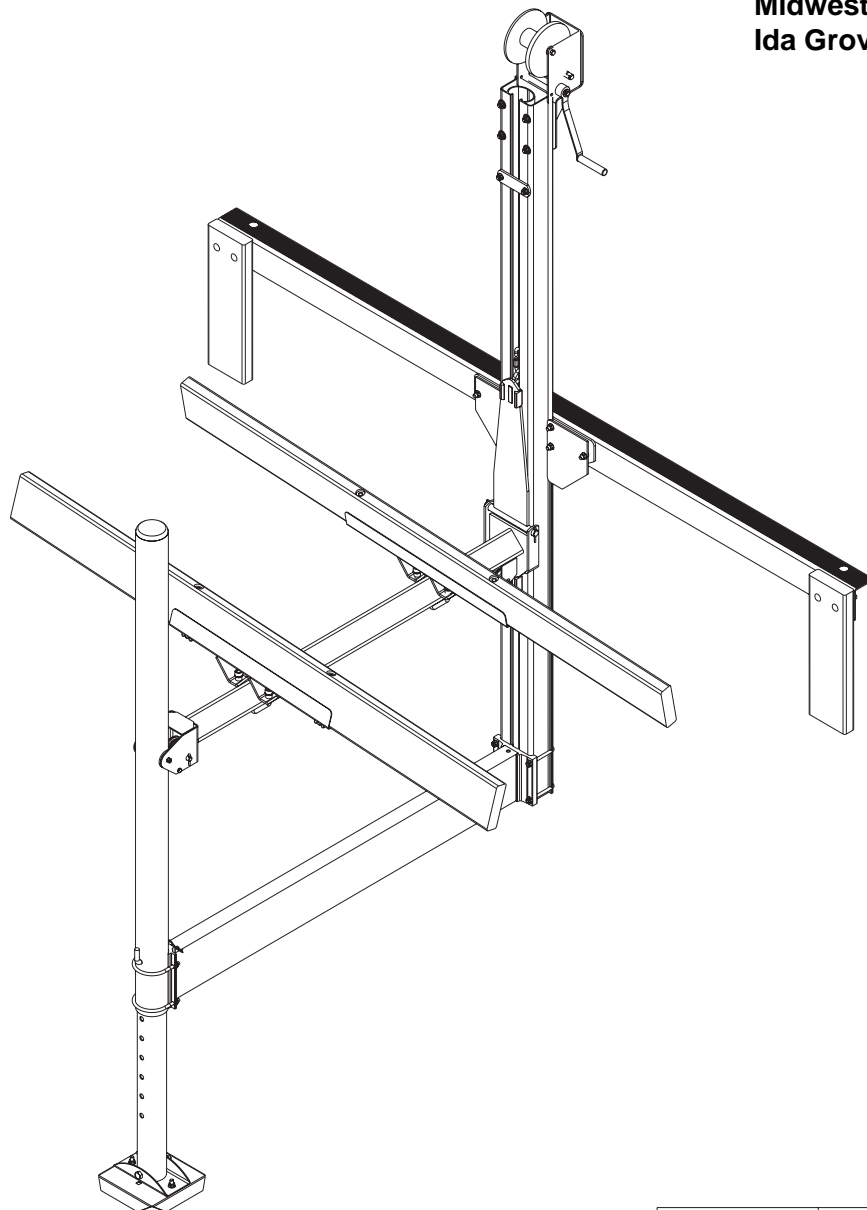

DWG: SS1053D\_MANUAL REV: 1.3+

ITEM	PART #	DESCRIPTION	QTY	NOTE
1	62538	BUNK CHANNEL WMENT LEFT	1	
2	62550	SQUARE BASE PAD	1	
3	62587	PWC DOCK BUMPER	2	
4	63435	BUNK CHANNEL WMENT RIGHT	1	
5	63732	1/2" PULLEY PIN	1	
6	66003	LOWER FRAME WMENT - DOCK MTG HOIST	1	
7	66006	UPPER LIFT ARM WMENT	1	
8	66014	PLATFORM WELDMENT - DOCK MOUNT	1	
9	66015	GUIDE POST TUBE	1	
10	66016	LEG ADJUSTMENT PIN	1	
11	66018	HOIST ATTACH PLATE	2	
12	66019	STOP PLATE	1	
13	66021	WINCH POST EXTRUSION - 90"	1	A
14	66023	PULLEY SPACER BUSHING	2	
15	66025	BUNK ASSY - LEFT 853/8531	1	
16	66026	BUNK ASSY - RIGHT 583/8531	1	
17	66033	PLATFORM ASSEMBLY SS853/8531DS	1	
18	66034	PLASTIC GUIDE WASHER - 853/8531	2	
19	66431	WINCH POST PLATE - SS853D	1	
20	66432	DOCK MOUNT ANGLE - SS853D	1	
21	68509	WINCH MTG BRACKET	1	
22	0110019	HH 1/4-20 X 4 1/2 CS GR5 ZP	1	
23	0110037	HH 3/8-16 X 1 1/4 CS GR5	3	
24	0110059	HH 3/8-16 X 3 3/4 CS GR5	6	
25	0110118	HH 1/2-13 X 4 1/2 CS GR5	1	
26	0120316	SCREW(PROJECTION WELD) 1/4-20 X 1/2	2	
27	0140040	HH 3/8-16 X 1 CS GR5	2	
28	0210139	CARR 3/8-16 X 6 FULL THREAD GR5	4	
29	0220110	CARR 3/8-16 X 1 1/2 FULL THREAD GR5	6	
30	0230070	CARR 5/16-18X2 1/4 AL FULL THD S	3	
31	0310295	SUB 3/8 X 5 3/16 X 3 7/8	2	
32	0320101	3/8-16 X 3 7/8 X 3 7/8 ROUND U-BOLT	2	
33	0330000	1/2-13 X 4 19/32 X 3 3/4 V-BOLT	2	
34	1310020	LOCKWASHER 1/4 S/T MED	2	
35	1310040	LOCKWASHER 1/2 S/T MED	4	
36	1340030	LOCKWASHER 3/8 S/T MED ULTRASEAL	4	
37	1340095	WASHER USS FLAT 3/8	8	
38	1410049	HEX NUT FINISH 1/4-20	2	
39	1410059	HEX LOCKNUT 1/4-20 GRA	1	
40	1410109	HEX NUT 3/8-16	5	
41	1410110	WING NUT 3/8-16	4	
42	1420069	HEX NUT 5/16-18 ALUMINUM 6061-T6	3	
43	1440101	HEX LOCKNUT FLANGE 3/8-16 W/T&T	25	
44	1440102	HEX LOCKNUT FLANGE 1/2-13 W/T&T	1	
45	1440159	HEX NUT FINISH 1/2-13	4	
46	1510078	COTTER KEY 3/16 X 1	4	
47	1520082	COTTER KEY 3/16 X 1 1/2	2	
48	1540300	HITCH PIN CLIP #7	1	
49	1910048	PULLEY PIN	1	
50	2210171	CHAIN QUICK LINK W/5/16 OPENING	1	
-	2400022	COVER FOR 2000 WINCH BLUE	1	
-	3110351	CABLE LEVEL III 1/2" STAINLESS	1	
51	3110391	WINCH DLB2000A W/72" STRAP	1	A
52	3510083	PLATFORM PULLEY W/BRONZE BUSHING	2	
53	3510126	SLIDE BLOCK - PWC DOCK MOUNT	2	
54	3810097	SPACER .5151D X 11/16OD X 7/16 LONG	4	
55	3910024	BUNKWOOD 2 X 6 X 12FT FIR	2	
56	A102	ADJUSTABLE LEG 3 1/8OD X 30 1/2	1	
57	A104	ALUM BASE PAD CHANNEL CLAMP	1	
58	A389	BLACK PLASTIC CAP	1	

NOTES	
A	FOR MODEL SS1053D USE 66022 WINCH TUBE EXTRUSION AND 3110392 WINCH WITH STRAP

## SS1053D / SS10531D Bundles Required

### SS1053D Dock Mount Hoist 1000 lbs.

66003 Lower Frame Wment 853/8531  
66427 Bunk Bundle 853D  
68516 Hardware Box 1053D  
66429 Leg Bundle SS853D  
66033 Platform Bundle 853D

### SS10531D Dock Mount Hoist 1000 lbs.

66003 Lower Frame Wment 853/8531  
66427 Bunk Bundle 853D  
68510 Hardware Box 10531D  
66433 Leg Bundle SS8531D  
66033 Platform Bundle 853/8531

## Tools Required

9/16" Socket/Wrench  
3/4" Socket/Wrench

## Replacement Parts

304980 72" WINCH STRAP/HANDLE-SS1053D  
304981 102" WINCH STRAP/HANDLE-SS10531D

# SS1053D / SS10531D Parts Drawing

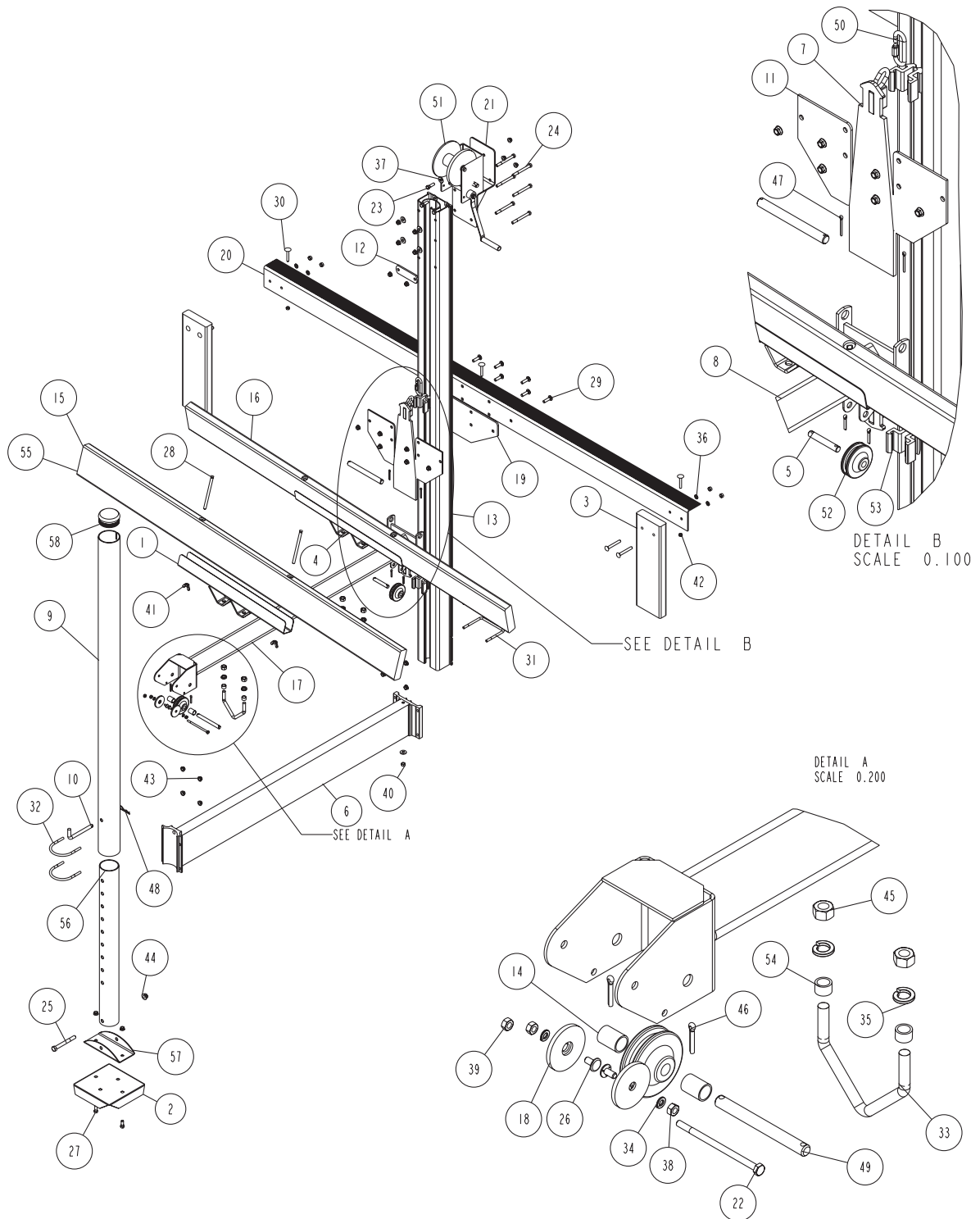

DWG: SS1053D\_MANUAL    REV: 1.3+

**SS1053D is shown in the parts  
break-down drawing**

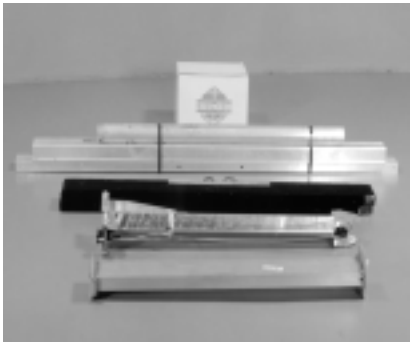

1. Bundles as shown.

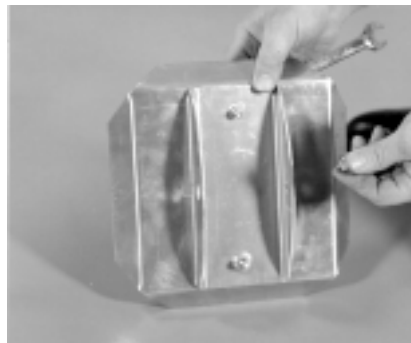

2. Install the aluminum base pad channel clamp to the base pad using two (2) 3/8" X 1" hex bolts and two (2) 3/8" flange lock nuts.

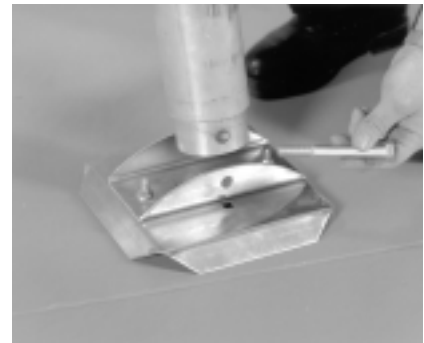

3. Mount the adjustable leg to the base pad channel using a 1/2" X 4-1/2" hex bolt and secure with a 1/2" flange lock nut.

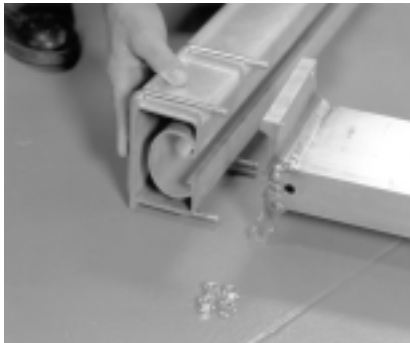

4. Mount the lower frame weldment to the winch post extrusion using two (2) 3/8" X 5-3/16" X 3-7/8" square u-bolts as shown. Secure with 3/8" flange lock nuts.

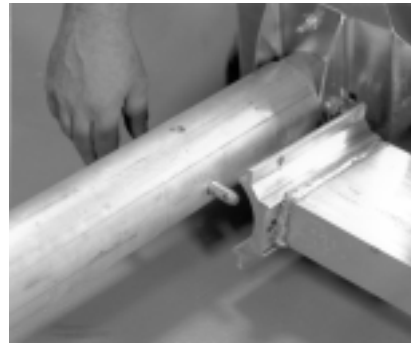

5. Mount the guide post tube to the opposite end of the lower frame weldment using a leg adjustment pin. Secure with a hitch pin clip.



6. Also mount the guide post tube to the opposite end of the lower frame tube using two (2) 3/8" X 3-7/8" X 3-7/8" RUB's. Secure with 3/8" flange lock nuts.

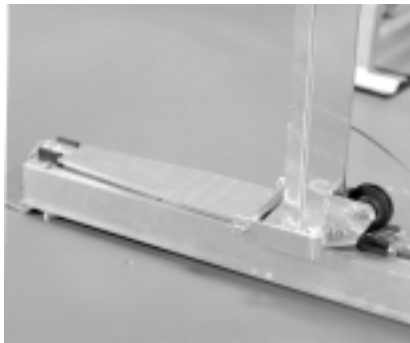

7. Slide the platform assembly into the winch post extrusion as shown.

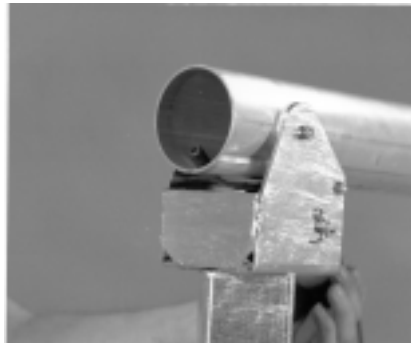

8. Slide the opposite end of the platform assembly over the guide post tube as shown. **Note: Be sure that the cable end is in the notch in the end of the guide post.**



9. Run the threaded end of the cable through the lower frame weldment as shown.

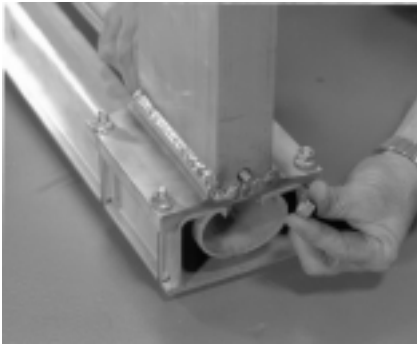

10. Secure the cable end to the under side of the lower frame weldment with a 3/8" flat washer and 3/8" hex nut.

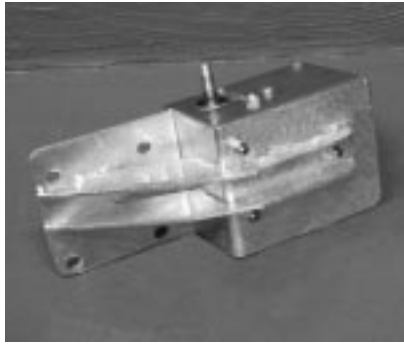

11. Mount the winch mounting plate to the winch assembly using three (3) 3/8" X 1" hex bolts. Place a 3/8" flat washer on each of the three (3) 3/8" X 1" bolts. Insert the bolts into the slots of the winch base. Align with the mounting holes in the winch mounting bracket. Secure with 3/8" flange lock nuts.



12. Mount the winch assembly with winch mounting bracket to the winch post extrusion using the four (4) 3/8" X 3-3/4" hex bolts just installed. Place a 3/8" flat washer on each of the four (4) 3/8" X 3-3/4" hex bolts. Insert them into the holes provided in the top of the winch post extrusion. Secure with 3/8" flange lock nuts.



13. Unwind the strap from the winch. Connect the end of the winch strap to the platform weldment assembly as shown.

**NOTE: The strap must be free of any twisting.**

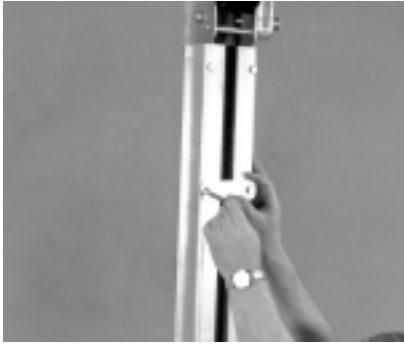

14. Mount the stop plate to the winch post extrusion using two (2) 3/8" X 3-3/4" hex bolts. Secure with 3/8" flange lock nuts.

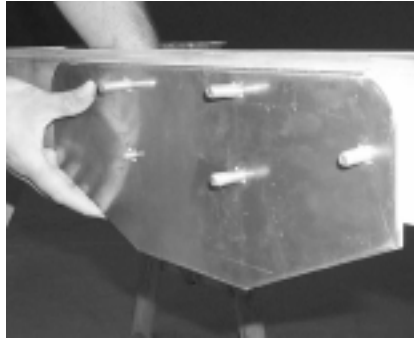

15. Place the winch post mounting plate to the dock angle using six (6) 3/8" X 1-1/2" carriage bolts.

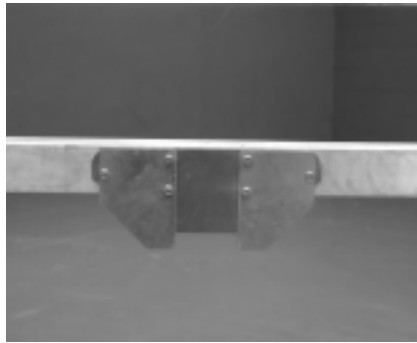

16. Mount the hoist attach plate to the winch post mounting plate over the six (6) 3/8" X 1-1/2" carriage bolts as shown. Secure with 3/8" flange lock nuts.



17. Lay the dock mounting angle onto the dock. (Do not secure to the dock until step 18 has been done.) Mount the dock bumpers and secure with 3/8" medium lock washers and 3/8" hex nuts.



18. Secure the dock mounting angle onto the dock with three (3) 5/16" X 2-1/4" carriage bolts and three (3) 5/16" hex nuts.



19. Insert the black plastic cap into the guide post tube as shown.



20. Slide the blue cover over the winch assembly as shown. This cover is used to protect the winch assembly from the weather.

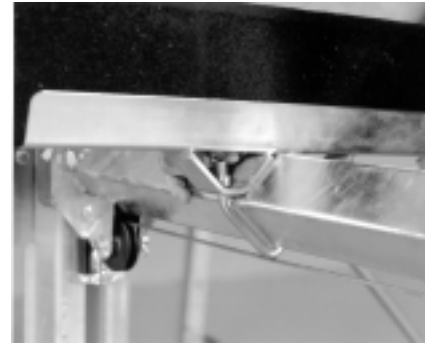

21. Mount the bunk with brackets onto the platform weldment using two (2) 1/2" v-shaped u-bolts, two (2) spacers, four (4) 1/2" lock washers and two (2) 1/2" hex nuts per bunk as shown. **Note: The short end of bunk from galvanized mounting channel goes to the right of the winch handle.** Repeat on other bunks. Bunks should be spaced to fit your watercraft before tightening. Bunks should also be angled toward the center of the platform. **NOTE: To enter the dock hoist from the other end - reverse the bunk assembly.**

---

## Positioning the PWC on the Hoist

The hoist is designed to raise and support the rated load as identified on the capacity labels on the hoist. However, for optimum performance the PWC must be properly positioned on the hoist platform when it is being raised. The hoist is designed to raise the load in the center of the load front to rear. The center of gravity of the PWC load being raised should be aligned with the vertical posts.

### Determining the Center of Gravity of the Machine

Many times the center of gravity of the machine will be located approximately at the center of the motor front to rear. This will be close in determining the position of the machine on the hoist front to rear for most two and three place machines. Four place machines may have the center of gravity located further rearward to approximately the center of the machines length front to rear. These are good starting points for determining the center of gravity on the standard machines. Moving your individual machine slightly forward or backward from here will get you very close to the center of gravity. Once identified, place an identifying mark, tape or decal at that location on the top outside edge of the PWC so you have a locating point to use when positioning the PWC on the hoist after use. This is accomplished by placing the PWC on the hoist until the mark, tape or decal is located opposite the vertical post.

Positioning the machine as described will reduce the internal friction and drag thus allowing your unit to be raised with less strain and force.

# Safety Tips

## “The best insurance policy is safety”

After the hoist installation is complete, it is important to next check and see that the winch mechanism is functioning properly. This is easily accomplished by raising the empty platform about one-fourth the way up and releasing your grasp on the lift handle. If the winch is operating properly, the clutch brake will automatically hold the platform at any position. Perform this same test in the half, three-fourths and full lift positions. Next, repeat this same procedure with your boat on the hoist. If the lift handle begins to freely spin down from any of these test positions, at no time should you attempt to prevent it from doing so. Such action could result in injury to arms and hands. Instead simply let the platform spin down into the water. Doing so will neither damage your hoist nor your watercraft.

If for some reason your winch mechanism does not function as described call your authorized Shore Station dealer. Do not tamper with the winch mechanism.

## SAFETY PRECAUTIONS

### DO NOT OPERATE THIS HOIST WITHOUT FIRST STUDYING THIS OWNER’S MANUAL

1. See to it that you, your family, and anyone else who uses the hoist looks upon the unit not as a toy, but a piece of heavy equipment that deserves your respect and good judgment.
2. Before allowing anyone to operate the unit, be sure they fully understand the proper operating procedure.
3. Do not exceed maximum capacity unit, overloading may cause mechanical failure and serious personal injury.
4. All persons should stand clear and should not be allowed to board your watercraft when it is being raised or lowered.
5. If you choose to remove the winch cover and inspect or work on the winch, be sure the platform is completely lowered.
6. It is a good safety policy to restrict children, as well as adults, from playing on or near the hoist.
7. Service winch annually. **IMPORTANT:** Winch maintenance schedule must be followed to avoid possible failure and injury. See winch owner’s manual for instructions.
8. Check cable for wear or fraying and also stress on cable attaching ends. If this occurs, replace cable immediately.
9. Be sure the hoist is installed level, severe out of level installation may cause hoist hand up and serious personal injury.
10. Do not work on you watercraft or hoist with watercraft on the hoist.
11. Check all sheaves, make sure they are turning and operating properly.
12. Check fasteners on cable ends to be positive they are threaded properly (see setting up instructions).
13. If the winch handle begins to freely spin down for any reason, at no time should you attempt to prevent it from doing so. Such action could result in injury to arms and hands. Instead, simply let the platform spin down into the water. Doing so will neither damage your watercraft or hoist.
14. Never pick up on platform of hoist while trying to move, position, or transport hoist. Doing so may cause serious personal injury.
15. Never stand or walk on hoist platform while in any raised position. Doing so may cause serious personal injury.

## SAFETY MAINTENANCE

It is recommended that your Shore Station hoist be thoroughly inspected at least once each season:

1. Tighten all bolts.
2. Check pulleys and make sure they are all turning freely.
3. Inspect all cables for fraying, wearing or deteriorating. If any signs appear, replace cables.
4. Check frame thoroughly.
5. Check winch as per manufacturer’s specifications.

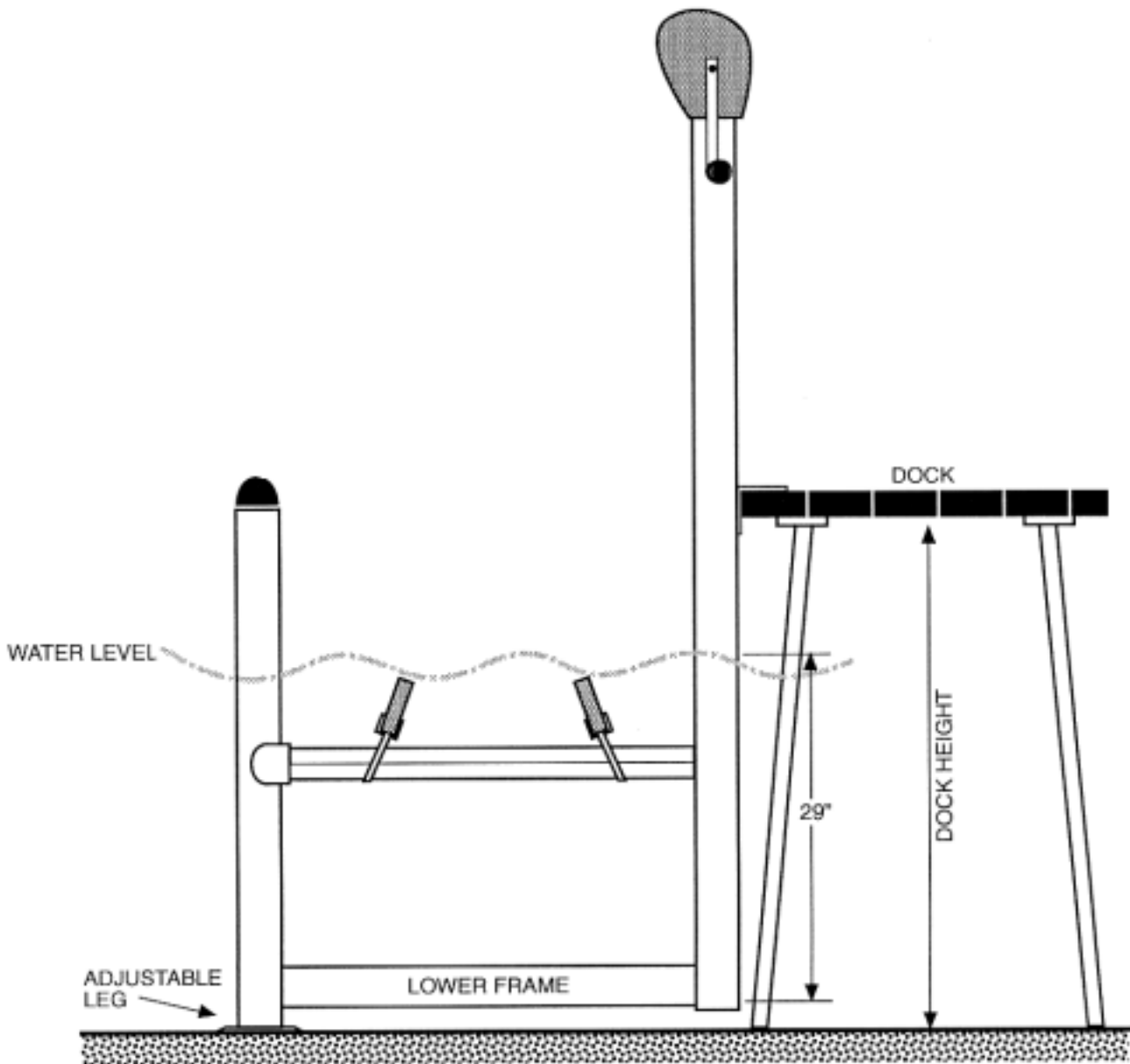

After final assembly, you are now ready for installation. Once the location is determined you need to find the water depth and the dock height.

Using a pole or a 2X4, insert it into the water and locate solid bottom to water level. Mark both the water level and the top of the on the 2X4.

Remove the pole and measure the distance from solid bottom to water level.

You must allow 17" for the lower cross member and bunk height, then add floatation allowance plus the water distance to the top of the dock figure, dock mount tube should be set at this measurement. Subtract this measurement from the lake bottom to the top of the dock measurement to get the leg extension measurement. **NOTE:** Allowances may have to be made for uneven lake bottom in the leg setting measurement.

The distance of dock to water line plus 29" equals position to set the top of the dock mount tube.